

Data sheet: Star-Z 20/4-3

Hydraulic data

Maximum operating pressure PN	10 bar
Delivery head for Q_{min} H_{Qmin}	4.7
Max. volume flow Q_{max}	3.7
Min. fluid temperature T_{min}	2 °C
Max. fluid temperature T_{max}	65 °C
Min. ambient temperature T_{min}	0 °C
Max. ambient temperature T_{max}	40 °C
Max. permitted total water hardness	3.21 mmol/l (18° dH)

Materials

Impeller	PPE-GF30
Shaft	Oxide ceramic
Bearing	Carbon, synthetic resin-impregnated

Information for order placements

Brand	Wilo
Product description	Star-Z 20/4-3
EAN number	4016322698043
Article number	4081193
Net weight, approx. m	2 kg
Gross weight, approx. m	2.4 kg
Length with packaging	147 mm
Height with packaging	100 mm
Width with packaging	187 mm
Packaging property	Sales packaging
Packaging type	Cardboard box
Minimum order quantity	1

Motor data

Mains connection	1~230 V, 50 Hz
Rated power P_2	22.5 W
Rated current I_N	0.31 A
Max. speed n_{max}	1900 rpm
Power consumption P_{1max}	71.0 W
Emitted interference	EN 61000-6-3
Interference resistance	EN 61000-6-2
Protection class motor	IP44
Insulation class	F
Threaded cable connection	1 x PG11
Motor protection	Not required (blocking-current proof)

Installation dimensions

Pipe connection on the suction side DNs	G 1¼
Pipe connection on the pressure side DNd	G 1¼
Port-to-port length l_0	150 mm

Dimensions and dimensions drawings: Star-Z 20/4-3

Star Z

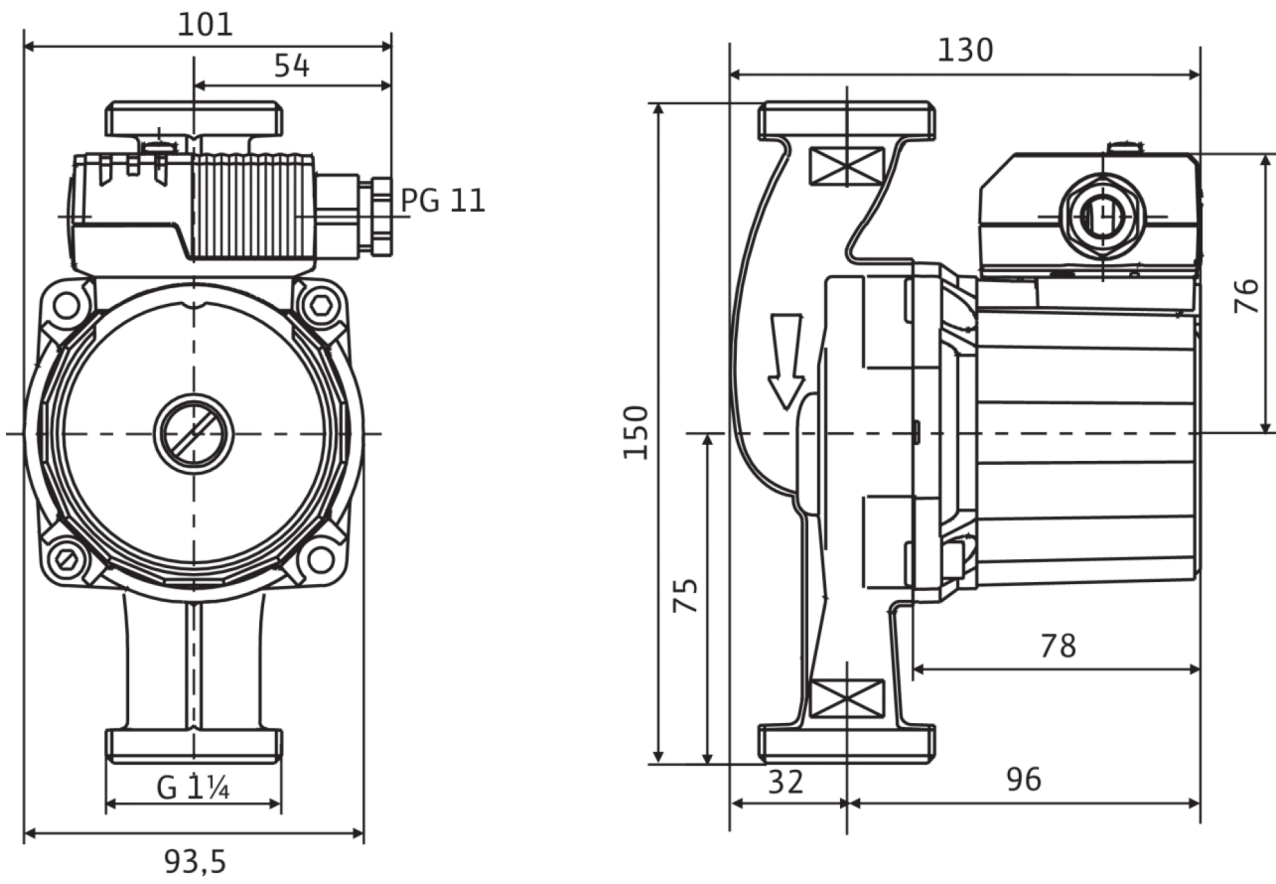

Pump curves: Star-Z 20/4-3

Star-Z 20/4, Single-phase current

